

Technical data sheet

Product features



Fry-top griddle plate 60x45 electric grooved without cabinet 400 V

Model	SAP Code	00001129
--------------	-----------------	----------



- Top type: Grooved
- Griddle dimensions [mm x mm]: 595 x 450
- Griddle thickness [mm]: 14.00
- Worktop material: Stainless steel
- Maximum device temperature [°C]: 300

SAP Code	00001129	Power electric [kW]	6.750
Net Width [mm]	600	Loading	400 V / 3N - 50 Hz
Net Depth [mm]	600	Griddle dimensions [mm x mm]	595 x 450
Net Height [mm]	280	Top type	Grooved
Net Weight [kg]	61.00		

Technical data sheet

Technical drawing



Fry-top griddle plate 60x45 electric grooved without cabinet 400 V

Model

SAP Code

00001129

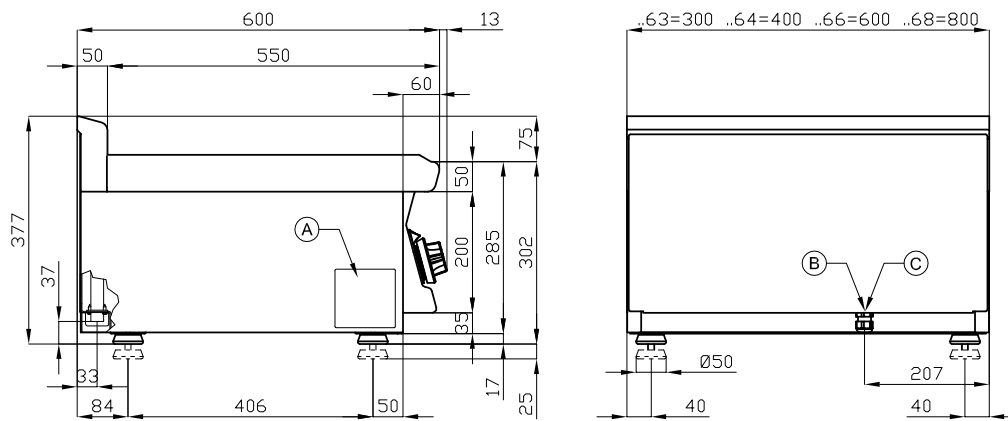

A	Data plate		B	Electrical connection	
---	------------	--	---	-----------------------	--

Technical data sheet

Product benefits



Fry-top griddle plate 60x45 electric grooved without cabinet 400 V

Model

SAP Code

00001129

1

All-stainless design

long life
resistance of AISI 304 stainless steel material
the material does not cut

- savings on service interventions
- easier and faster operation

2

Degree of protection of the control elements IPX5

maintenance-free system
resistance to splash water
long life

- savings on service interventions
- easy cleaning and maintenance of equipment

3

Outlet for waste liquids

ensures that oil drips into the socket

- easy maintenance
- easy cleaning

4

High detachable hem

better hygienic conditions
preventing grease from splashing onto
ancillary equipment

- easy maintenance
- easy cleaning

5

Ribbed steel plate

fast heat transfer and the surface will not be scratched
a good warming of the meat with a groove

- time-saving in food preparation
- easy preparation of good-looking food

6

Cooking unit for use on a table or on a base

variable use
the possibility of placement in smaller spaces

- easy handling
- cost savings on substructure

Technical data sheet

Technical parameters



Fry-top griddle plate 60x45 electric grooved without cabinet 400 V

Model

SAP Code

00001129

1. SAP Code:

00001129

2. Net Width [mm]:

600

3. Net Depth [mm]:

600

4. Net Height [mm]:

280

5. Net Weight [kg]:

61.00

6. Gross Width [mm]:

630

7. Gross depth [mm]:

690

8. Gross Height [mm]:

610

9. Gross Weight [kg]:

66.00

10. Device type:

Electric unit

11. Construction type of device:

Table top

12. Power electric [kW]:

6.750

13. Loading:

400 V / 3N - 50 Hz

14. Protection of controls:

IPX5

15. Device color:

Stainless steel

16. Material:

AISI 304 top plate and cladding

17. Indicators:

operation and warm-up

18. Worktop material:

Stainless steel

19. Worktop Thickness [mm]:

2.50

20. Maximum device temperature [°C]:

300

21. Minimum device temperature [°C]:

50

22. Service accessibility:

Trough the frontal panel

23. Safety thermostat:

Yes

24. Adjustable feet:

Yes

25. Griddle dimensions [mm x mm]:

595 x 450

26. Griddle thickness [mm]:

14.00

27. Top type:

Grooved