

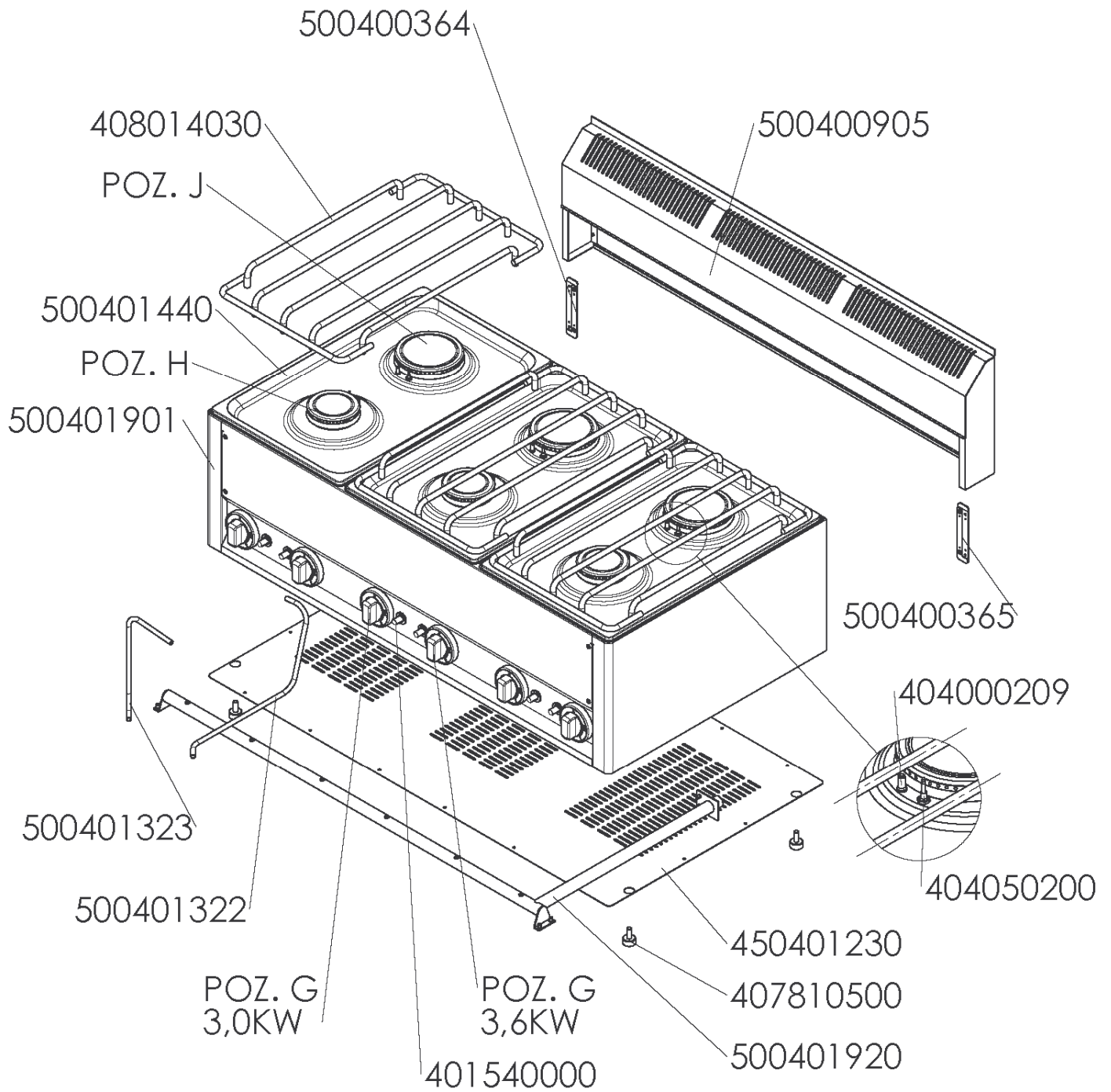

SPL-99 G
od 10-2012



SPL-99 G
od 10-2012

POZ. H – 3,0KW
POZ. J – 3,6KW

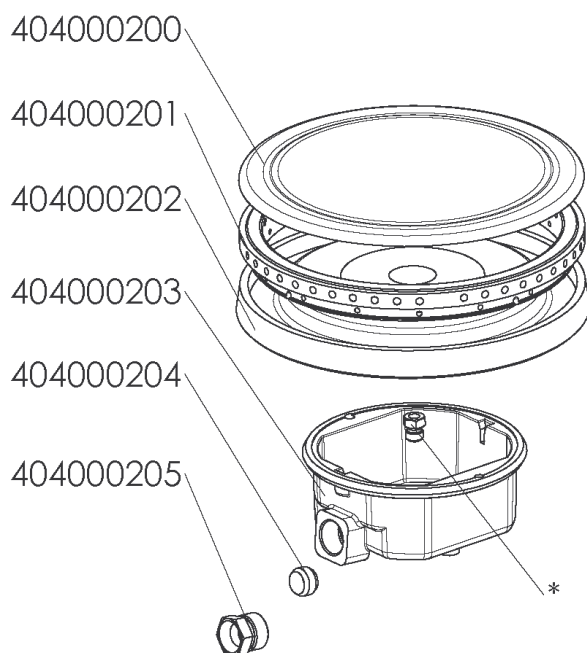
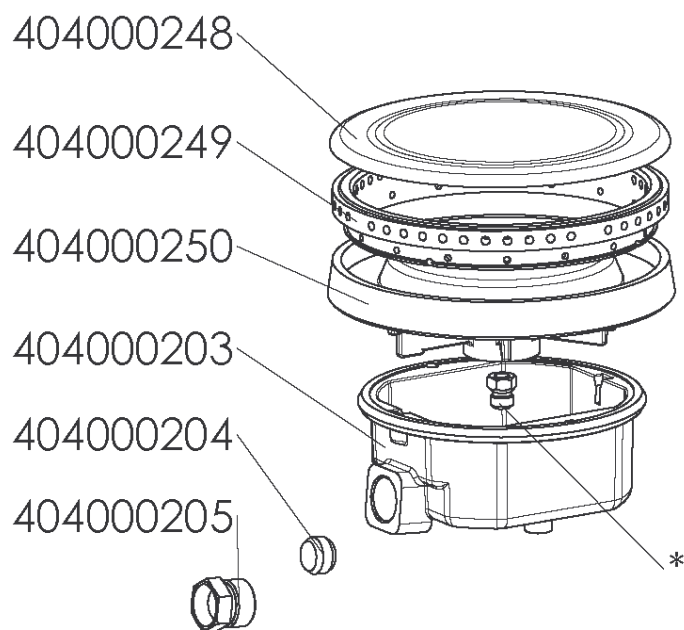



SPL-99 G
od 10-2012

POZ. G

