

Technical data sheet



Product features

Electric fryer 0,38 kW/l, 8 l counter top drain tap 230 V

Model	SAP Code	00000893
--------------	-----------------	----------



- Basin volume [l]: 8
- Drain type: On the front panel
- Drain: Yes
- Maximum device temperature [°C]: 190
- Minimum device temperature [°C]: 50
- Material: Stainless steel
- Heating location: Inside the tank
- Ignition: Electric
- Number of baskets: 1

SAP Code	00000893	Power electric [kW]	3.000
Net Width [mm]	306	Loading	230 V / 1N - 50 Hz
Net Depth [mm]	441	Basin volume [l]	8
Net Height [mm]	381	Number of baskets	1
Net Weight [kg]	8.50		

Technical data sheet



Technical drawing

Electric fryer 0,38 kW/l, 8 l counter top drain tap 230 V

Model

SAP Code

00000893

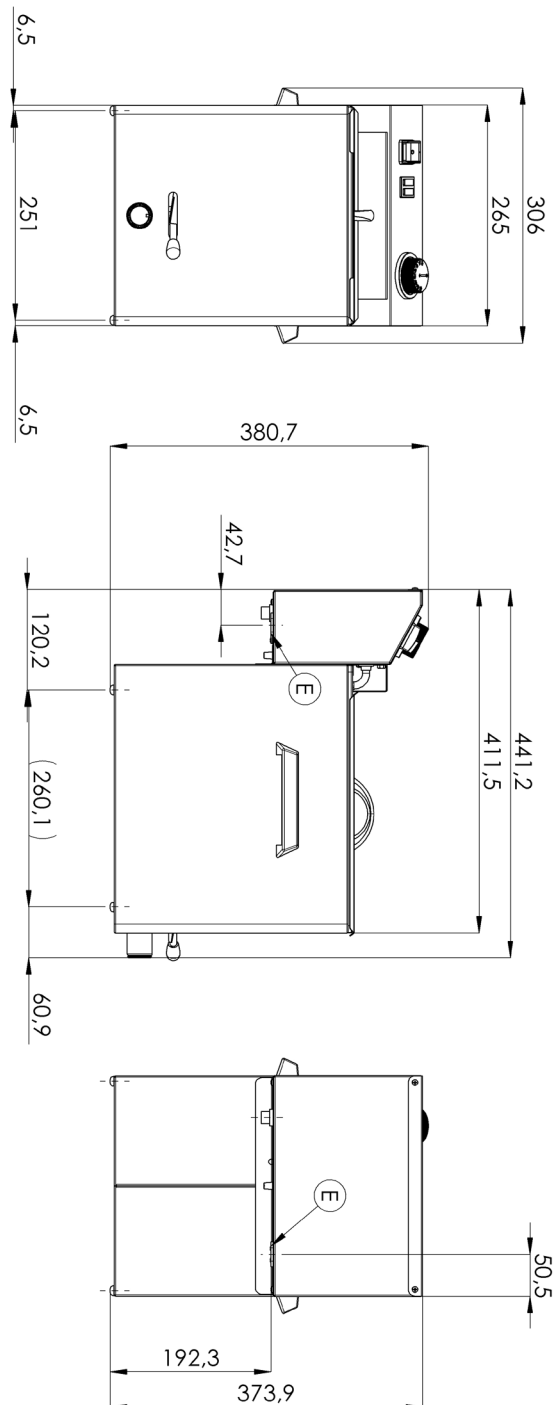

Electric fryer 0,38 kW/l, 8 l counter top drain tap 230 V

Model

SAP Code

00000893

1

All-stainless design

long life
resistance of AISI 304 stainless steel material
the material does not cut

- savings on service interventions
- easier and faster operation

2

Degree of protection of the control elements IPX4

maintenance-free system
resistance to splash water
long life

- savings on service interventions
- easy cleaning and maintenance of equipment

3

Effective cold zone

prevents food residues from burning
there is no change in the taste of the oil

- longer oil life
- easy access and maintenance

4

Removable heating element

longer lifetime
easy access

- fully removable electric box with heating element for convenient cleaning and servicing
- easy access even to corners and time saving

5

Removable container

stainless steel container with handles

- easier cleaning and handling
- dishwasher safe

6

Manipulation

easy portability

- flexibility in the kitchen, can be used for banquets

7

Prevention of spontaneous combustion

higher rear chimney

- safer heat dissipation and separation of oil and ventilation from the fryer

8

2 thermostats

safety and working thermostat

- traffic safety
- prevention of spontaneous combustion
- Prevention of oil flashover

Technical data sheet



Technical parameters

Electric fryer 0,38 kW/l, 8 l counter top drain tap 230 V

Model

SAP Code

00000893

1. SAP Code:

00000893

2. Net Width [mm]:

306

3. Net Depth [mm]:

441

4. Net Height [mm]:

381

5. Net Weight [kg]:

8.50

6. Gross Width [mm]:

515

7. Gross depth [mm]:

310

8. Gross Height [mm]:

440

9. Gross Weight [kg]:

9.50

10. Device type:

Electric unit

11. Construction type of device:

Table top

12. Power electric [kW]:

3.000

13. Loading:

230 V / 1N - 50 Hz

14. Ignition:

Electric

15. Protection of controls:

IPX4

16. Material:

Stainless steel

17. Indicators:

operation and warm-up

18. Worktop material:

AISI 304

19. Worktop Thickness [mm]:

0.80

20. Standard equipment for device:

lid, basket, drain plug

21. Basin volume [l]:

8

22. Maximum device temperature [°C]:

190

23. Minimum device temperature [°C]:

50

24. Safety thermostat up to x °C:

235

25. Adjustable feet:

Yes

26. Heating element material:

AISI 304

27. Number of baskets:

1

28. Heating element construction:

Large surface area coiled heating element to extend its life and heat the oil bath evenly

Technical data sheet



Technical parameters

Electric fryer 0,38 kW/l, 8 l counter top drain tap 230 V

Model	SAP Code	00000893
--------------	-----------------	----------

29. Drain type:

On the front panel

31. Heating location:

Inside the tank

30. Drain:

Yes