

# Technical data sheet



## Product features

### Food display island heated, glass ceramic GN 3-1/1 Wenge

<b>Model</b>	<b>SAP Code</b>	00012150
--------------	-----------------	----------



- Buffet type: BROWN - heated, glass-ceramic
- Device properties: Warmed
- Number of GN / EN: 3
- GN / EN size in device: GN 1/1
- Minimum device temperature [°C]: 60
- Maximum device temperature [°C]: 100

<b>SAP Code</b>	00012150	<b>Loading</b>	230 V / 1N - 50 Hz
<b>Net Width [mm]</b>	1169	<b>Number of GN / EN</b>	3
<b>Net Depth [mm]</b>	650	<b>GN / EN size in device</b>	GN 1/1
<b>Net Height [mm]</b>	1288	<b>Minimum device temperature [°C]</b>	60
<b>Net Weight [kg]</b>	78.00	<b>Maximum device temperature [°C]</b>	100
<b>Power electric [kW]</b>	0.855		

# Technical data sheet



Technical drawing

Food display island heated, glass ceramic GN 3-1/1 Wenge

Model

SAP Code

00012150

A = ELECTRICAL CONNECTION  
D = WATER DISCHARGE Ø14

GN	L
3/1	1169
4/1	1494
6/1	2144

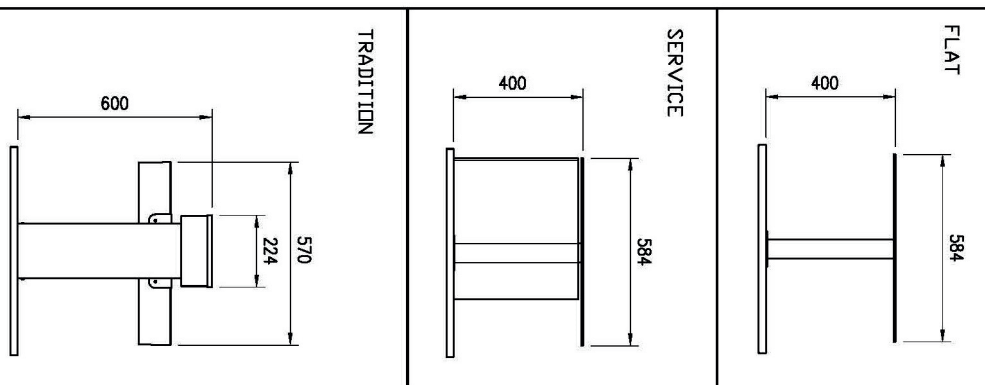
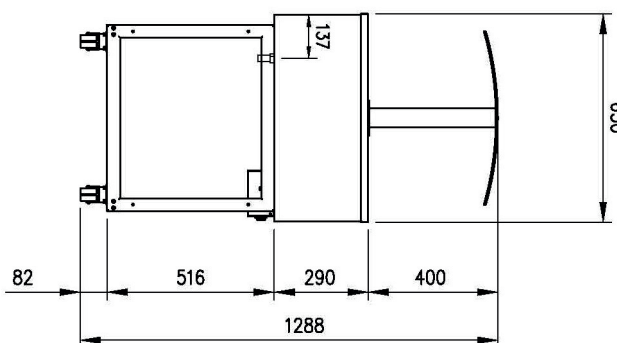
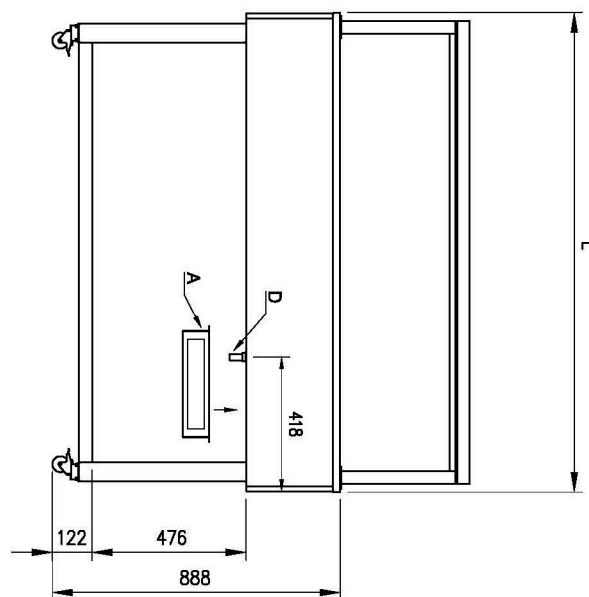
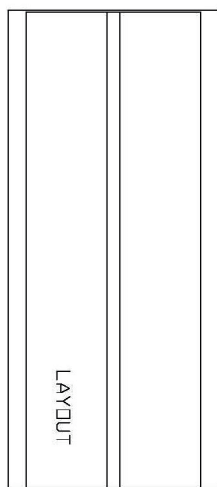

# Technical data sheet



## Product benefits

### Food display island heated, glass ceramic GN 3-1/1 Wenge

Model

SAP Code

00012150

1

#### Glass ceramic plate

- smooth hard surface
- endurance
  - easy maintenance
  - long service life

2

#### No press

- without sharp edges and corners
  - higher hygienic safety
  - time saving due to easy cleaning

3

#### All-stainless steel construction

- harmless to health for contact with food
- robustness
  - long service life
  - very easy to clean

4

#### Halogen lighting

- heating from above
  - more even heating of food
  - greater hygienic safety

5

#### Travel wheels

- portable buffet table
  - greater flexibility in dispensing
  - possibility of use at banquets
  - easier and safer handling

6

#### Breath galley

- galerka made of hygienic pexiglass with infrared heating
  - hygienic food protection
  - heating and lighting of food from above

# Technical data sheet



## Technical parameters

Food display island heated, glass ceramic GN 3-1/1 Wenge

Model

SAP Code

00012150

**1. SAP Code:**

00012150

**2. Net Width [mm]:**

1169

**3. Net Depth [mm]:**

650

**4. Net Height [mm]:**

1288

**5. Net Weight [kg]:**

78.00

**6. Gross Width [mm]:**

1230

**7. Gross depth [mm]:**

730

**8. Gross Height [mm]:**

1100

**9. Gross Weight [kg]:**

92.90

**10. Device type:**

Electric unit

**11. Buffet type:**

BROWN - heated, glass-ceramic

**12. Device properties:**

Warmed

**13. Device color:**

Hemlock

**14. Power electric [kW]:**

0.855

**15. Loading:**

230 V / 1N - 50 Hz

**16. Number of GN / EN:**

3

**17. GN / EN size in device:**

GN 1/1

**18. Minimum device temperature [°C]:**

60

**19. Maximum device temperature [°C]:**

100