

Technical data sheet

Product features



Fry-top griddle plate 76x51 gas chromed grooved on open cabinet

Model	SAP Code	00001118
--------------	-----------------	----------



- Top type: Grooved
- Griddle dimensions [mm x mm]: 760 x 510
- Griddle thickness [mm]: 14.00
- Worktop material: Super chrom
- Container for liquid fat: Yes
- Independent heating zones: Separate control for each heating zone
- Maximum device temperature [°C]: 300
- Removable rim: Yes
- Ignition: Piezo+večný plamen

SAP Code	00001118	Power gas [kW]	14.000
Net Width [mm]	800	Type of gas	Natural gas, propane butane
Net Depth [mm]	705	Griddle dimensions [mm x mm]	760 x 510
Net Height [mm]	900	Top type	Grooved
Net Weight [kg]	101.00	Worktop type	Molded - comfortable cleaning maintenance

Technical data sheet

Technical drawing



Fry-top griddle plate 76x51 gas chromed grooved on open cabinet

Model

SAP Code

00001118

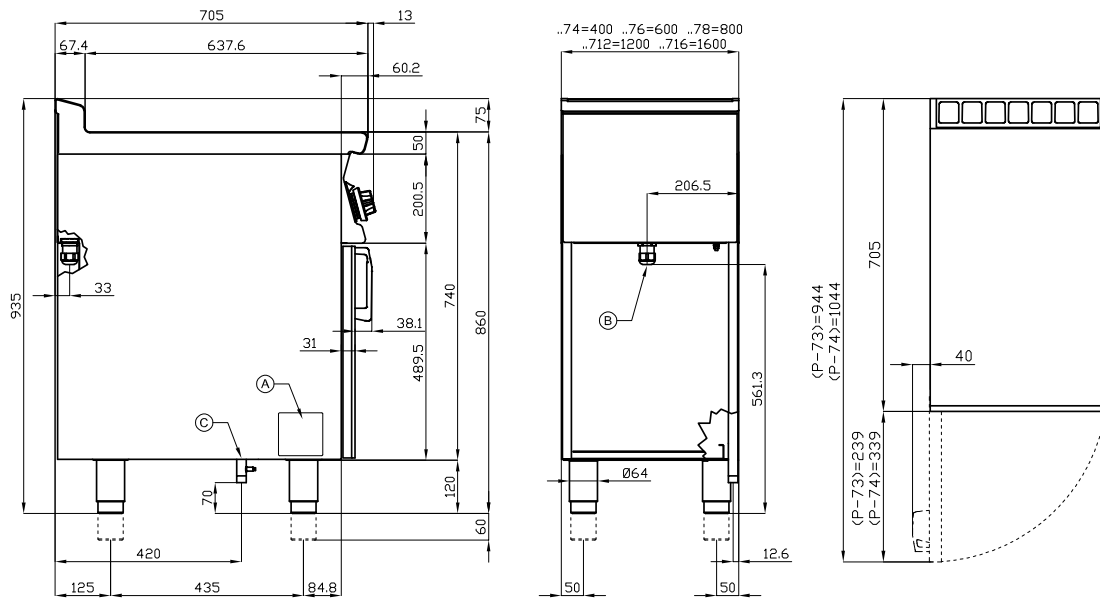

A	Data plate		C	Gas connection	ISO 7-1 1/2" M
---	------------	--	---	----------------	----------------

Technical data sheet

Product benefits



Fry-top griddle plate 76x51 gas chromed grooved on open cabinet

Model

SAP Code

00001118

1

Safety element – thermocouple

safe service for staff
there is no unnecessary gas leakage
long life

- savings on service interventions
- easier and faster operation

2

All-stainless design

long life
resistance of AISI 304 stainless steel material
the material does not cut

- savings on service interventions
- easy cleaning and maintenance of equipment

3

Degree of protection of the control elements IPX5

maintenance-free system
resistance to splash water
long life

- savings on service interventions
- easy cleaning and maintenance of equipment

4

Outlet for waste liquids

ensures that oil drips into the socket

- easy maintenance
- easy cleaning

5

High detachable hem

better hygienic conditions
preventing grease from splashing onto
ancillary equipment

- easy maintenance
- easy cleaning

6

Grooved plate made of chrome-plated steel

the product bakes less and is easier to clean
a good warming of the meat with a groove

- time-saving in food preparation
- easy preparation of good-looking food

7

Surface treatment “Superchrom”

a thicker layer of protective chrome applied with
new technology

- the top is more scratch resistant
- more convenient and faster handling of food
on the plate
- the possibility of preparing more delicate
types of food
- the plate does not get dirty, does not swell

Technical data sheet

Technical parameters



Fry-top griddle plate 76x51 gas chromed grooved on open cabinet

Model

SAP Code

00001118

1. SAP Code:

00001118

2. Net Width [mm]:

800

3. Net Depth [mm]:

705

4. Net Height [mm]:

900

5. Net Weight [kg]:

101.00

6. Gross Width [mm]:

830

7. Gross depth [mm]:

770

8. Gross Height [mm]:

1110

9. Gross Weight [kg]:

114.00

10. Device type:

Gas unit

11. Construction type of device:

Stationary

12. Power gas [kW]:

14.000

13. Ignition:

Piezo+večný plamen

14. Type of gas:

Natural gas, propane butane

15. Protection of controls:

IPX5

16. Device color:

Stainless steel

17. Material:

Stainless steel

18. Indicators:

operation and warm-up

19. Worktop type:

Molded - comfortable cleaning maintenance

20. Worktop material:

Super chrom

21. Worktop Thickness [mm]:

2.00

22. Maximum device temperature [°C]:

300

23. Minimum device temperature [°C]:

50

24. Power control type:

knob control

25. Service accessibility:

Trough the frontal panel

26. Safety element:

safety thermostat

27. Safety thermostat:

Yes

28. Adjustable feet:

Yes

Technical data sheet

Technical parameters



Fry-top griddle plate 76x51 gas chromed grooved on open cabinet

Model

SAP Code

00001118

29. Additional information:

door not included - can be purchased

30. Griddle dimensions [mm x mm]:

760 x 510

31. Griddle thickness [mm]:

14.00

32. Container for liquid fat:

Yes

33. Independent heating zones:

Separate control for each heating zone

34. Removable rim:

Yes

35. Uniform heating:

Yes

36. Top type:

Grooved