

# Technical data sheet



Product features

## Open stand mobile 40x60

Model

SAP Code

00003160



– Material: Stainless steel

# Technical data sheet



Technical drawing

Open stand mobile 40x60

Model

SAP Code

00003160

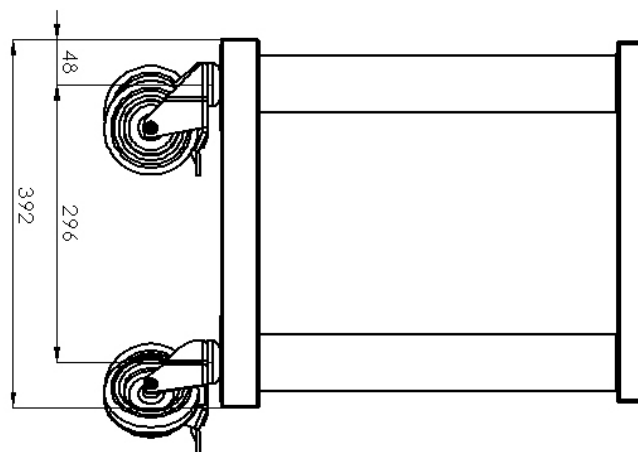
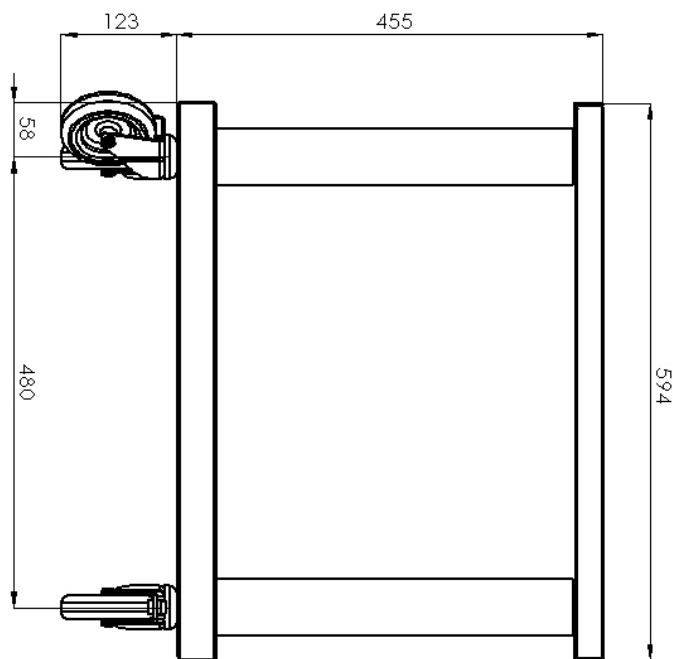

# Technical data sheet



Technical parameters

## Open stand mobile 40x60

Model

SAP Code

00003160

**1. SAP Code:**

00003160

**6. Gross Width [mm]:**

410

**2. Net Width [mm]:**

390

**7. Gross depth [mm]:**

610

**3. Net Depth [mm]:**

600

**8. Gross Height [mm]:**

580

**4. Net Height [mm]:**

570

**9. Gross Weight [kg]:**

13.00

**5. Net Weight [kg]:**

12.50

**10. Material:**

Stainless steel