

Technical data sheet



Product features

Hot dog machine 1 spike

Model	SAP Code	00001447
--------------	-----------------	----------



- Material: Aluminium
- Indicators: operation and warm-up
- Maximum device temperature [°C]: 100

SAP Code	00001447	Net Weight [kg]	2.07
Net Width [mm]	210	Power electric [kW]	0.100
Net Depth [mm]	219	Loading	230 V / 1N - 50 Hz
Net Height [mm]	241	Maximum device temperature [°C]	100

Technical data sheet



Technical drawing

Hot dog machine 1 spike

Model

SAP Code

00001447

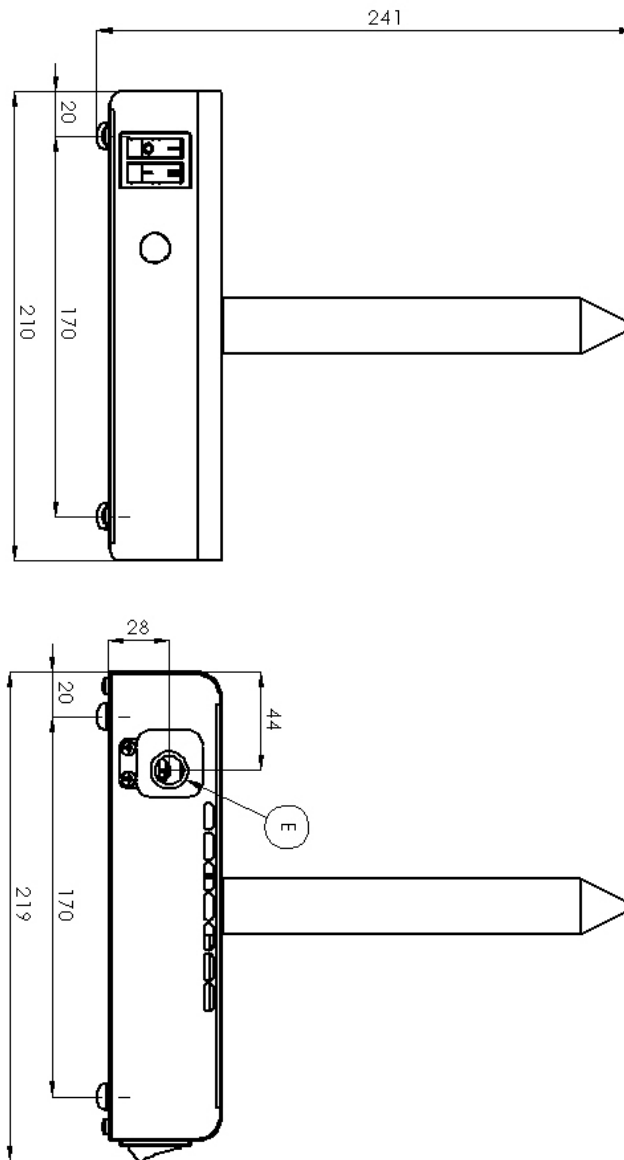

Technical data sheet



Product benefits

Hot dog machine 1 spike

Model	SAP Code	
		00001447

1

All-stainless design

only stainless steel intended for food contact is used

- absolutely rust-proof and non-magnetic design
- resists even weak acids easier compliance with hygiene standards (HACCP); easy maintenance and cleaning

2

Run and warm-up light

optical possibility to check the status of the device

- the operator immediately knows the on/off, heating/ non-heating state of the appliance

3

Heating mandrels made of brushed aluminum

non-stick heat-conducting surface

- quick heating of the mandrel and unbroken pastry

4

Separate control for each drive delete completely

I can control both parts of the Hot Dog independently

- better controllability and energy saving

5

Power switch

standard mode and rapid heating mode

- possibility of faster heating up
- possibility to regulate the heating temperature

Technical data sheet



Technical parameters

Hot dog machine 1 spike

Model	SAP Code	00001447
--------------	-----------------	----------

1. SAP Code:

00001447

2. Net Width [mm]:

210

3. Net Depth [mm]:

219

4. Net Height [mm]:

241

5. Net Weight [kg]:

2.07

6. Gross Width [mm]:

230

7. Gross depth [mm]:

230

8. Gross Height [mm]:

290

9. Gross Weight [kg]:

2.40

10. Device type:

Electric unit

11. Construction type of device:

Table top

12. Material:

Aluminium

13. Power electric [kW]:

0.100

14. Loading:

230 V / 1N - 50 Hz

15. Maximum device temperature [°C]:

100

16. Protection of controls:

IPX4

17. Energy Saving system:

Energy saving mode

18. Indicators:

operation and warm-up